

Varenummer: 201461B302SW
Beskrivelse: E+G Flange lineærenhed
GN146.1-B30-2-SW

Mål

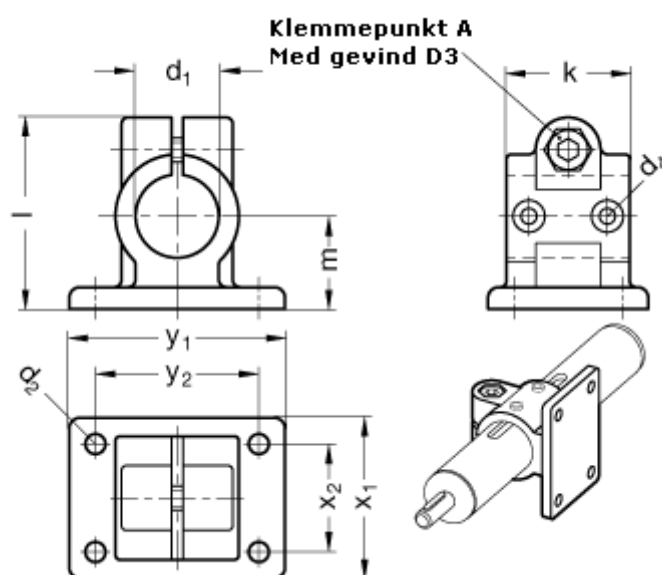

d1 = B30	x2 = 35
d2 = 6,5	y1 = 70
d3 = M 8	y2 = 53
d4 = M 4	
k = 40	
l = 62	
m = 30	
x1 = 52	